



Very Low Power/Voltage CMOS SRAM 256K X 16 bit

BS616LV4010

■ FEATURES

- Very low operation voltage : 2.7 ~ 3.6V
- Very low power consumption :
 - Vcc = 3.0V C-grade: 20mA (Max.) operating current
 - I -grade: 25mA (Max.) operating current
 - 0.5uA (Typ.) CMOS standby current
- High speed access time :
 - 70 70ns (Max.) at Vcc = 3.0V
 - 10 100ns (Max.) at Vcc = 3.0V
- Automatic power down when chip is deselected
- Three state outputs and TTL compatible
- Fully static operation
- Data retention supply voltage as low as 1.5V
- Easy expansion with CE and OE options
- I/O Configuration x8/x16 selectable by LB and UB pin

■ DESCRIPTION

The BS616LV4010 is a high performance, very low power CMOS Static Random Access Memory organized as 262,144 words by 16 bits and operates from a wide range of 2.7V to 3.6V supply voltage. Advanced CMOS technology and circuit techniques provide both high speed and low power features with a typical CMOS standby current of 0.5uA and maximum access time of 70ns in 3V operation. Easy memory expansion is provided by an active LOW chip enable(CE) and active LOW output enable(OE) and three-state output drivers. The BS616LV4010 has an automatic power down feature, reducing the power consumption significantly when chip is deselected. The BS616LV4010 is available in DICE form, JEDEC standard 44-pin TSOP Type II package and 48-pin BGA package.

■ PRODUCT FAMILY

PRODUCT FAMILY	OPERATING TEMPERATURE	Vcc RANGE	SPEED (ns) Vcc=3.0V	POWER DISSIPATION		PKG TYPE
				STANDBY (IccsB1, Max) Vcc=3.0V	Operating (Icc, Max) Vcc=3.0V	
BS616LV4010DC	+0°C to +70°C	2.7V ~ 3.6V	70 / 100	8uA	20mA	DICE
BS616LV4010EC						TSOP2-44
BS616LV4010AC						BGA-48-0608
BS616LV4010BC						BGA-48-0810
BS616LV4010DI	-40°C to +85°C	2.7V ~ 3.6V	70 / 100	12uA	25mA	DICE
BS616LV4010EI						TSOP2-44
BS616LV4010AI						BGA-48-0608
BS616LV4010BI						BGA-48-0810

■ PIN CONFIGURATIONS

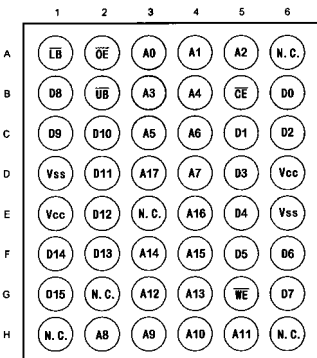
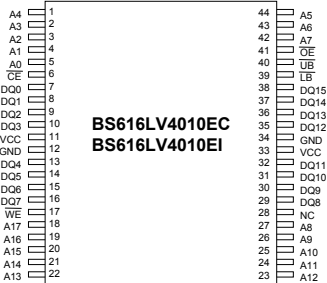

48-ball CSP - Top View

■ BLOCK DIAGRAM

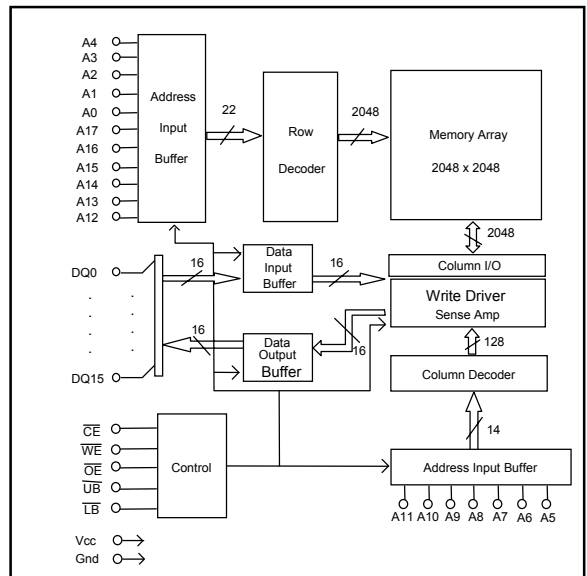

Brilliance Semiconductor, Inc. reserves the right to modify document contents without notice.

■ PIN DESCRIPTIONS

Name	Function
A0-A17 Address Input	These 18 address inputs select one of the 262,144 x 16-bit words in the RAM.
\overline{CE} Chip Enable Input	\overline{CE} is active LOW. Chip enables must be active to read from or write to the device. If chip enable is not active, the device is deselected and is in a standby power mode. The DQ pins will be in the high impedance state when the device is deselected.
\overline{WE} Write Enable Input	The write enable input is active LOW and controls read and write operations. With the chip selected, when \overline{WE} is HIGH and \overline{OE} is LOW, output data will be present on the DQ pins; when \overline{WE} is LOW, the data present on the DQ pins will be written into the selected memory location.
\overline{OE} Output Enable Input	The output enable input is active LOW. If the output enable is active while the chip is selected and the write enable is inactive, data will be present on the DQ pins and they will be enabled. The DQ pins will be in the high impedance state when \overline{OE} is inactive.
\overline{LB} and \overline{UB} Data Byte Control Input	Lower byte and upper byte data input/output control pins.
DQ0 - DQ15 Data Input/Output Ports	These 16 bi-directional ports are used to read data from or write data into the RAM.
Vcc	Power Supply
Gnd	Ground

■ TRUTH TABLE

MODE	\overline{CE}	\overline{WE}	\overline{OE}	\overline{LB}	\overline{UB}	DQ0~DQ7	DQ8~DQ15	Vcc CURRENT
Not selected (Power Down)	H	X	X	X	X	High Z	High Z	I_{CCSB} , I_{CCSB1}
Output Disabled	L	H	H	X	X	High Z	High Z	I_{CC}
Read	L	H	L	L	L	Dout	Dout	I_{CC}
				H	L	High Z	Dout	I_{CC}
				L	H	Dout	High Z	I_{CC}
Write	L	L	X	L	L	Din	Din	I_{CC}
				H	L	X	Din	I_{CC}
				L	H	Din	X	I_{CC}

■ ABSOLUTE MAXIMUM RATINGS⁽¹⁾

SYMBOL	PARAMETER	RATING	UNITS
V _{TERM}	Terminal Voltage with Respect to GND	-0.5 to V _{CC} +0.5	V
T _{BIAS}	Temperature Under Bias	-40 to +125	°C
T _{STG}	Storage Temperature	-60 to +150	°C
PT	Power Dissipation	1.0	W
I _{OUT}	DC Output Current	20	mA

1. Stresses greater than those listed under ABSOLUTE MAXIMUM RATINGS may cause permanent damage to the device. This is a stress rating only and functional operation of the device at these or any other conditions above those indicated in the operational sections of this specification is not implied. Exposure to absolute maximum rating conditions for extended periods may affect reliability.

■ OPERATING RANGE

RANGE	AMBIENT TEMPERATURE	V _{CC}
Commercial	0 °C to +70 °C	2.7V ~ 3.6V
Industrial	-40 °C to +85 °C	2.7V ~ 3.6V

■ CAPACITANCE⁽¹⁾ (TA = 25°C, f = 1.0 MHz)

SYMBOL	PARAMETER	CONDITIONS	MAX.	UNIT
C _{IN}	Input Capacitance	V _{IN} =0V	6	pF
CDQ	Input/Output Capacitance	V _{I/O} =0V	8	pF

1. This parameter is guaranteed and not 100% tested.

■ DC ELECTRICAL CHARACTERISTICS (TA = 0 to + 70°C)

PARAMETER NAME	PARAMETER	TEST CONDITIONS	MIN. TYP. ⁽¹⁾ MAX.			UNITS
V _{IL}	Guaranteed Input Low Voltage ⁽²⁾	V _{CC} =3.0V	-0.5	--	0.8	V
V _{IH}	Guaranteed Input High Voltage ⁽²⁾	V _{CC} =3.0V	2.0	--	V _{CC} +0.2	V
I _{IL}	Input Leakage Current	V _{CC} = Max, V _{IN} = 0V to V _{CC} V _{CC} =3.0V	--	--	1	uA
I _{LO}	Output Leakage Current	V _{CC} = Max, $\overline{CE} = V_{IH}$, or $\overline{OE} = V_{IH}$, V _{I/O} = 0V to V _{CC}	--	--	1	uA
V _{OL}	Output Low Voltage	V _{CC} = Max, I _{OL} = 2mA V _{CC} =3.0V	--	--	0.4	V
V _{OH}	Output High Voltage	V _{CC} = Min, I _{OH} = -1mA V _{CC} =3.0V	2.4	--	--	V
I _{CC}	Operating Power Supply Current	$\overline{CE} = V_{IL}$, I _{DD} = 0mA, F = F _{max} ⁽³⁾ V _{CC} =3.0V	--	--	20	mA
I _{CCSB}	Standby Current-TTL	$\overline{CE} = V_{IH}$, I _{DD} = 0mA V _{CC} =3.0V	--	--	1	mA
I _{CCSB1}	Standby Current-CMOS	$\overline{CE} \geq V_{CC}-0.2V$, V _{IN} \geq V _{CC} - 0.2V or V _{IN} \leq 0.2V V _{CC} =3.0V	--	0.5	8	uA

1. Typical characteristics are at TA = 25°C.

2. These are absolute values with respect to device ground and all overshoots due to system or tester noise are included.

3. F_{max} = 1/t_{RC}.

■ DATA RETENTION CHARACTERISTICS (TA = 0 to + 70°C)

SYMBOL	PARAMETER	TEST CONDITIONS	MIN. TYP. ⁽¹⁾ MAX.			UNITS
V _{DR}	V _{CC} for Data Retention	$\overline{CE} \geq V_{CC} - 0.2V$ V _{IN} \geq V _{CC} - 0.2V or V _{IN} \leq 0.2V	1.5	--	--	V
I _{CCDR}	Data Retention Current	$\overline{CE} \geq V_{CC} - 0.2V$ V _{IN} \geq V _{CC} - 0.2V or V _{IN} \leq 0.2V	--	0.3	1	uA
t _{CDR}	Chip Deselect to Data Retention Time	See Retention Waveform	0	--	--	ns
t _R	Operation Recovery Time		T _{RC} ⁽²⁾	--	--	ns

1. V_{CC} = 1.5V, T_A = + 25°C

2. t_{RC} = Read Cycle Time

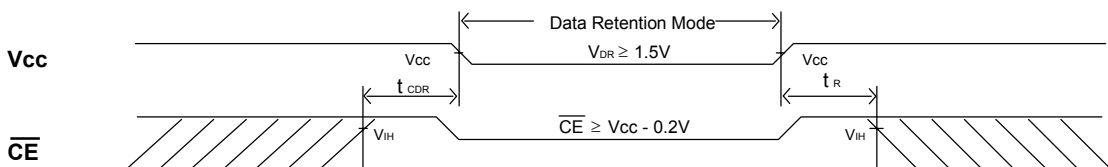
■ LOW V_{CC} DATA RETENTION WAVEFORM (\overline{CE} Controlled)

■ AC TEST CONDITIONS

Input Pulse Levels	$V_{CC}/0V$
Input Rise and Fall Times	1V/ns
Input and Output Timing Reference Level	0.5 V_{CC}

■ KEY TO SWITCHING WAVEFORMS

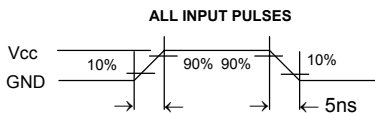
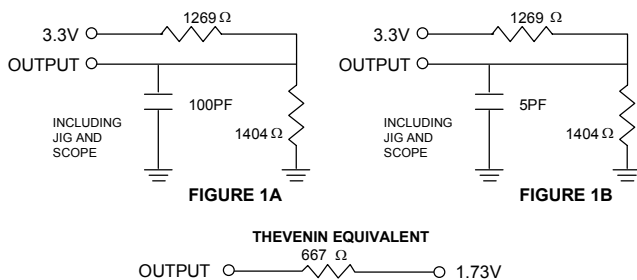
WAVEFORM	INPUTS	OUTPUTS
	MUST BE STEADY	MUST BE STEADY
	MAY CHANGE FROM H TO L	WILL BE CHANGE FROM H TO L
	MAY CHANGE FROM L TO H	WILL BE CHANGE FROM L TO H
	DON'T CARE: ANY CHANGE PERMITTED	CHANGE: STATE UNKNOWN
	DOES NOT APPLY	CENTER LINE IS HIGH IMPEDANCE "OFF" STATE

■ AC TEST LOADS AND WAVEFORMS

FIGURE 2
■ AC ELECTRICAL CHARACTERISTICS ($T_A = 0$ to $+70^\circ C$, $V_{CC} = 3.0V$)
READ CYCLE

JEDEC PARAMETER NAME	PARAMETER NAME	DESCRIPTION	CYCLE TIME : 70ns			CYCLE TIME : 100ns			UNIT
			MIN.	TYP.	MAX.	MIN.	TYP.	MAX.	
t_{AVAX}	t_{RC}	Read Cycle Time	70	--	--	100	--	--	ns
t_{AVQV}	t_{AA}	Address Access Time	--	--	70	--	--	100	ns
t_{ELQV}	t_{ACS}	Chip Select Access Time (\overline{CE})	--	--	70	--	--	100	ns
t_{BA}	$t_{BA}^{(1)}$	Data Byte Control Access Time ($\overline{LB}, \overline{UB}$)	--	--	35	--	--	50	ns
t_{GLQV}	t_{OE}	Output Enable to Output Valid	--	--	35	--	--	50	ns
t_{ELQX}	t_{CLZ}	Chip Select to Output Low Z (\overline{CE})	10	--	--	15	--	--	ns
t_{BE}	t_{BE}	Data Byte Control to Output Low Z ($\overline{LB}, \overline{UB}$)	10	--	--	15	--	--	ns
t_{GLQX}	t_{OLZ}	Output Enable to Output in Low Z	10	--	--	15	--	--	ns
t_{EHQZ}	t_{CHZ}	Chip Deselect to Output in High Z (\overline{CE})	--	--	35	--	--	40	ns
t_{BDO}	t_{BDO}	Data Byte Control to Output High Z ($\overline{LB}, \overline{UB}$)	--	--	35	--	--	40	ns
t_{GHQZ}	t_{OHZ}	Output Disable to Output in High Z	--	--	30	--	--	35	ns
t_{AXOX}	t_{OH}	Data Hold from Address Change	10	--	--	15	--	--	ns

NOTE :

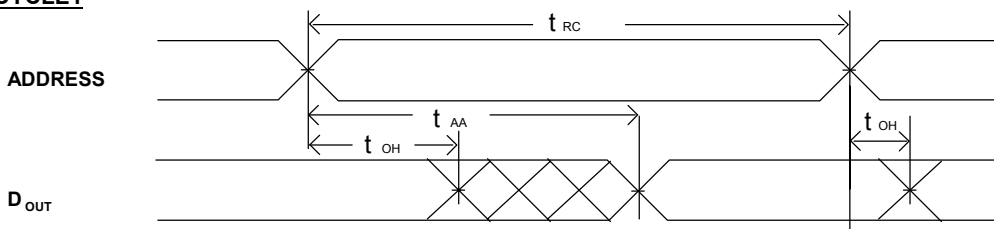
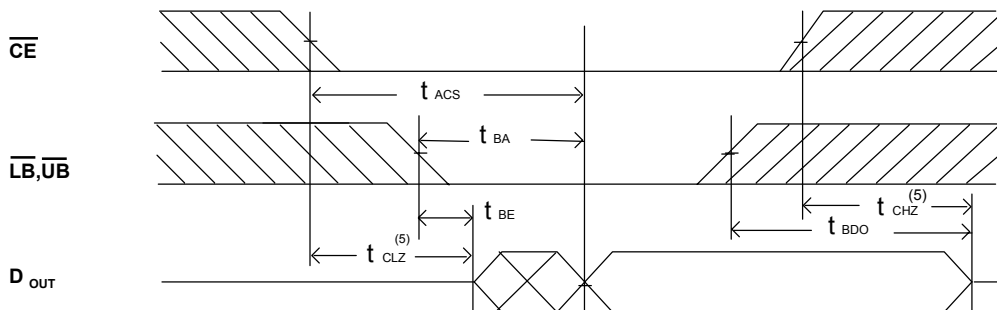
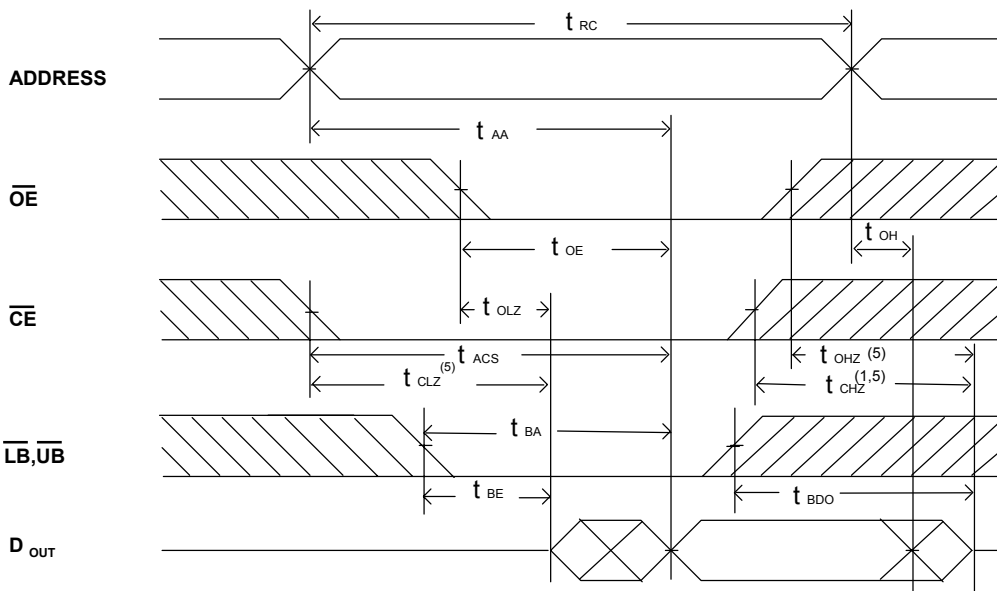
 1. t_{BA} is 35ns/50ns (@speed=70ns/100ns) with address toggle. ; t_{BA} is 70ns/100ns (@speed=70ns/100ns) without address toggle.

SWITCHING WAVEFORMS (READ CYCLE)
READ CYCLE1 (1,2,4)

READ CYCLE2 (1,3,4)

READ CYCLE3 (1,4)

NOTES:

1. \overline{WE} is high in read Cycle.
2. Device is continuously selected when $\overline{CE} = V_{IL}$.
3. Address valid prior to or coincident with \overline{CE} transition low.
4. $\overline{OE} = V_{IL}$.
5. Transition is measured $\pm 500\text{mV}$ from steady state with $C_L = 5\text{pF}$ as shown in Figure 1B. The parameter is guaranteed but not 100% tested.

■ AC ELECTRICAL CHARACTERISTICS (TA = 0 to + 70°C , Vcc = 3.0V)
WRITE CYCLE

JEDEC PARAMETER NAME	PARAMETER NAME	DESCRIPTION	CYCLE TIME : 70ns			CYCLE TIME : 100ns			UNIT
			MIN.	TYP.	MAX.	MIN.	TYP.	MAX.	
t_{AVAX}	t_{WC}	Write Cycle Time	70	--	--	100	--	--	ns
t_{E1LWH}	t_{CW}	Chip Select to End of Write	70	--	--	100	--	--	ns
t_{AVWL}	t_{AS}	Address Setup Time	0	--	--	0	--	--	ns
t_{AVWH}	t_{AW}	Address Valid to End of Write	70	--	--	100	--	--	ns
t_{WLWH}	t_{WP}	Write Pulse Width	35	--	--	50	--	--	ns
t_{WHAX}	t_{WR1}	Write recovery Time ($\overline{CE}, \overline{WE}$)	0	--	--	0	--	--	ns
t_{BW}	$t_{BW}^{(1)}$	Date Byte Control to End of Write ($\overline{LB}, \overline{UB}$)	30	--	--	40	--	--	ns
t_{WLQZ}	t_{WHZ}	Write to Output in High Z	--	--	30	--	--	40	ns
t_{DVWH}	t_{DW}	Data to Write Time Overlap	30	--	--	40	--	--	ns
t_{WHDX}	t_{DH}	Data Hold from Write Time	0	--	--	0	--	--	ns
t_{GHQZ}	t_{OHZ}	Output Disable to Output in High Z	--	--	30	--	--	40	ns
t_{WHOX}	t_{OW}	End of Write to Output Active	5	--	--	10	--	--	ns

NOTE :

 1. t_{BW} is 30ns/40ns (@speed=70ns/100ns) with address toggle. ; t_{BW} is 70ns/100ns (@speed=70ns/100ns) without address toggle.

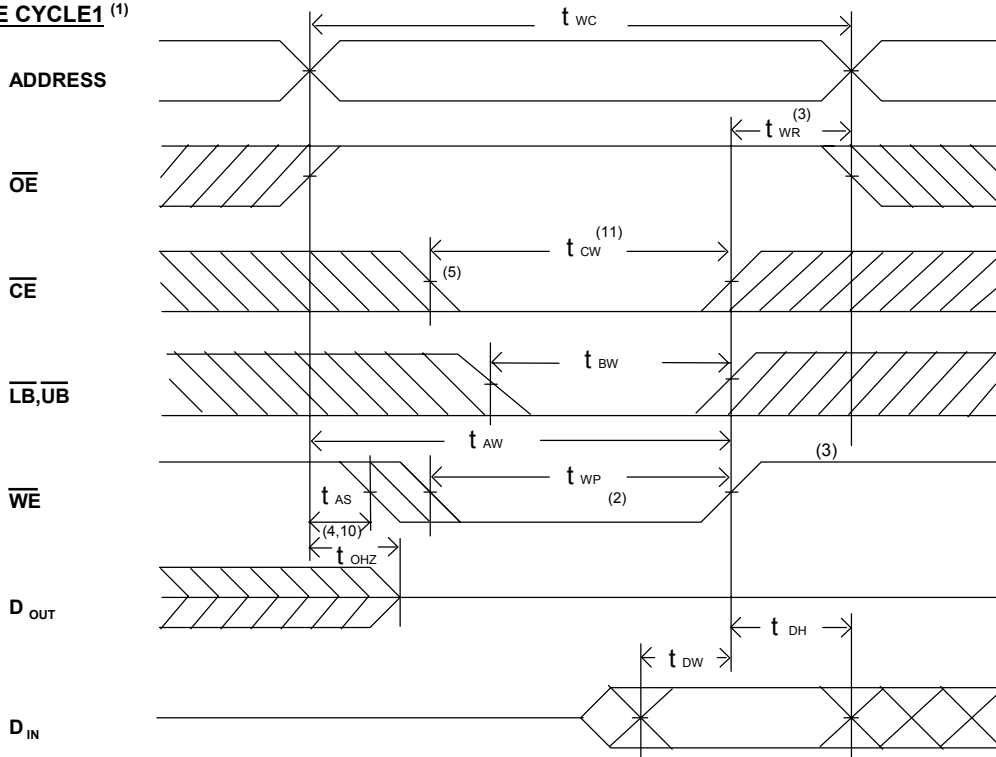
■ SWITCHING WAVEFORMS (WRITE CYCLE)
WRITE CYCLE1⁽¹⁾

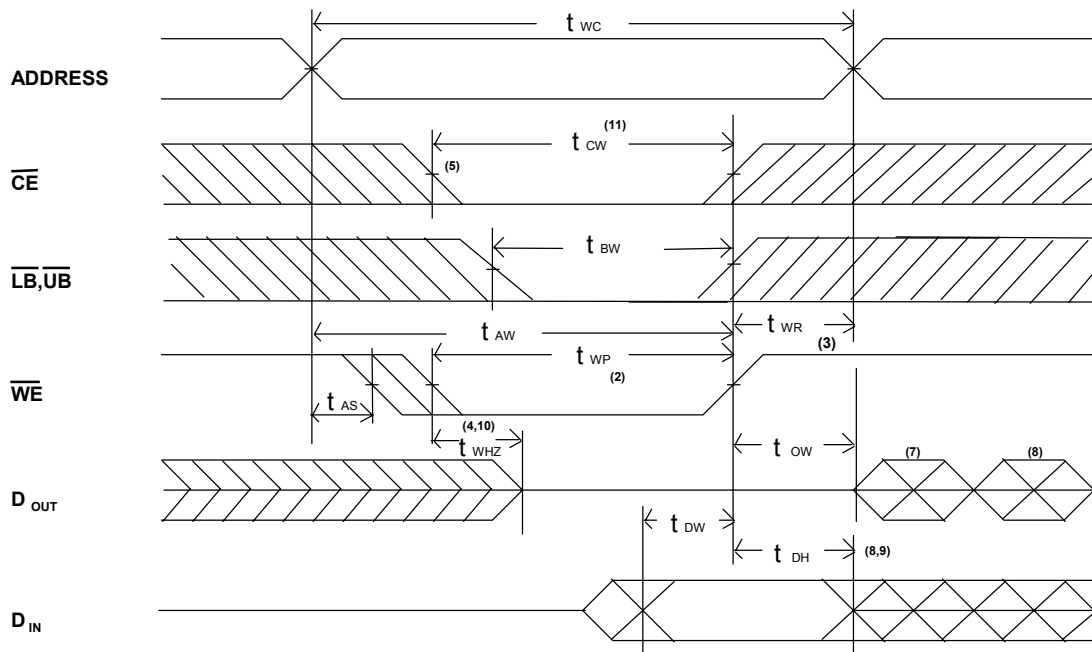
WRITE CYCLE2 (1,6)

NOTES:

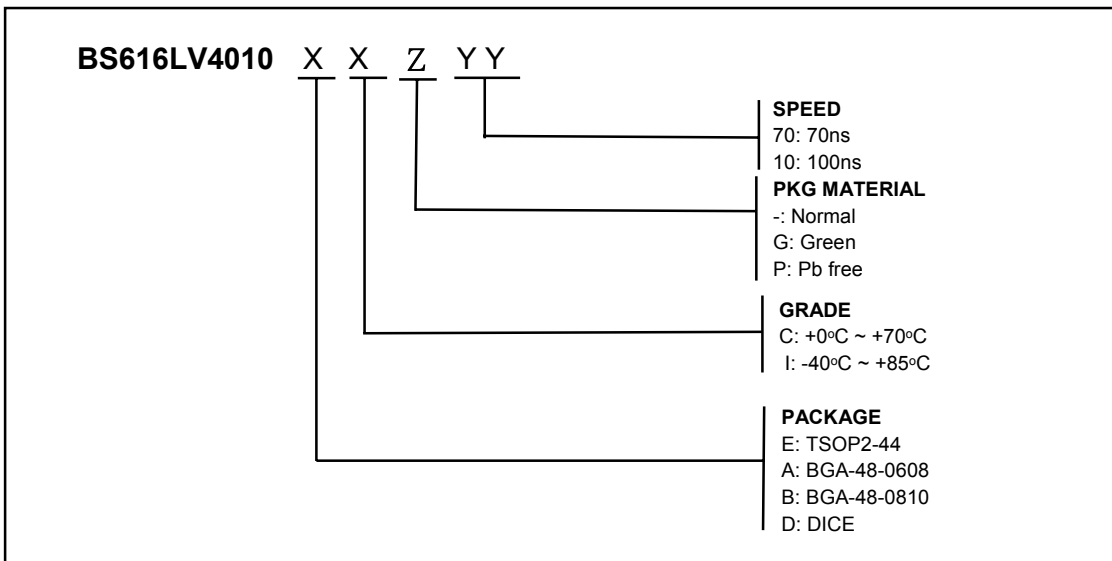
1. \overline{WE} must be high during address transitions.
2. The internal write time of the memory is defined by the overlap of \overline{CE} and \overline{WE} low. All signals must be active to initiate a write and any one signal can terminate a write by going inactive. The data input setup and hold timing should be referenced to the second transition edge of the signal that terminates the write.
3. t_{wr} is measured from the earlier of \overline{CE} or \overline{WE} going high at the end of write cycle.
4. During this period, DQ pins are in the output state so that the input signals of opposite phase to the outputs must not be applied.
5. If the \overline{CE} low transition occurs simultaneously with the \overline{WE} low transitions or after the \overline{WE} transition, output remain in a high impedance state.
6. \overline{OE} is continuously low ($\overline{OE} = V_{IL}$).
7. D_{OUT} is the same phase of write data of this write cycle.
8. D_{OUT} is the read data of next address.
9. If \overline{CE} is low during this period, DQ pins are in the output state. Then the data input signals of opposite phase to the outputs must not be applied to them.
10. Transition is measured $\pm 500mV$ from steady state with $C_L = 5pF$ as shown in Figure 1B. The parameter is guaranteed but not 100% tested.
11. t_{cw} is measured from the later of \overline{CE} going low to the end of write.

ORDERING INFORMATION

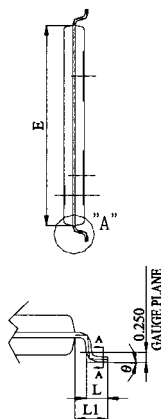
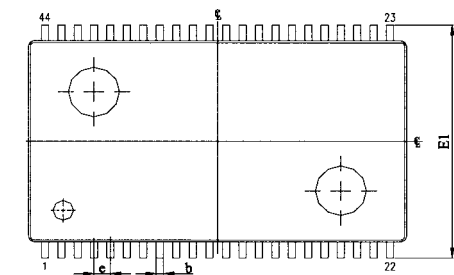
Note:

BSI (Brilliance Semiconductor Inc.) assumes no responsibility for the application or use of any product or circuit described herein. BSI does not authorize its products for use as critical components in any application in which the failure of the BSI product may be expected to result in significant injury or death, including life-support systems and critical medical instruments.

PACKAGE DIMENSIONS

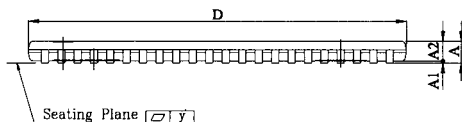
UNIT	INCH	MM
A	0.0433± 0.004	1.10± 0.10
A1	0.004± 0.002	0.10± 0.05
A2	0.039± 0.002	1.00± 0.05
b	0.012 ~ 0.018	0.30 ~ 0.45
b1	0.012 ~ 0.016	0.30 ~ 0.40
c	0.005 ~ 0.008	0.12 ~ 0.21
c1	0.005 ~ 0.006	0.12 ~ 0.16
D	0.725± 0.004	18.41± 0.10
E	0.400± 0.004	10.16± 0.10
E1	0.463± 0.008	11.76± 0.20
e	0.0315± 0.004	0.80± 0.10
L	0.0197± 0.004	0.50± 0.10
L1	0.0315± 0.004	0.80± 0.10
y	0.004 Max.	0.1 Max.
θ	0° ~ 8°	0° ~ 8°



DETAIL "A" (2:1)

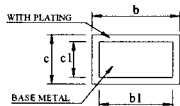

SECTION A-A

TSOP2-44

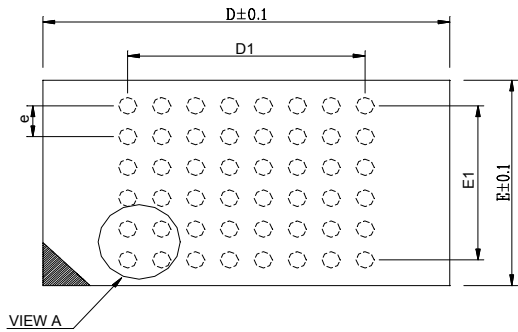
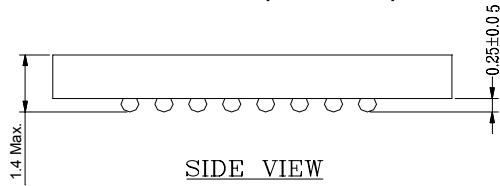
■ PACKAGE DIMENSIONS (continued)

48 mini-BGA (6 x 8mm)
NOTES:

- 1: CONTROLLING DIMENSIONS ARE IN MILLIMETERS.
- 2: PIN#1 DOT MARKING BY LASER OR PAD PRINT.
- 3: SYMBOL "N" IS THE NUMBER OF SOLDER BALLS.

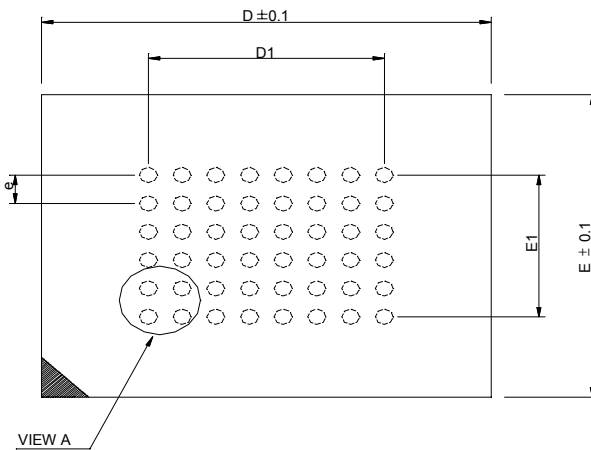
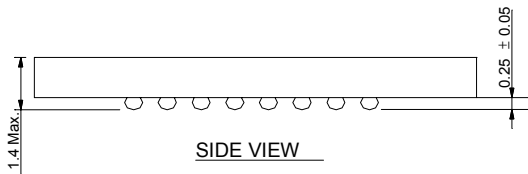
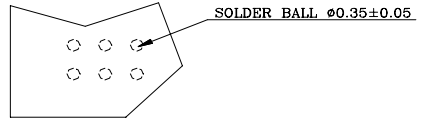
BALL PITCH e = 0.75				
D	E	N	D1	E1
8.0	6.0	48	5.25	3.75

48 mini-BGA (8 x 10mm)
NOTES:

- 1: CONTROLLING DIMENSIONS ARE IN MILLIMETERS.
- 2: PIN#1 DOT MARKING BY LASER OR PAD PRINT.
- 3: SYMBOL "N" IS THE NUMBER OF SOLDER BALLS.

N	D	E	D1	E1	e
48	10.0	8.0	5.25	3.75	0.75

